



X-SERIES™

LASER SHAFT
ALIGNMENT

X-880

5-AXIS
ALIGNMENT TOOL

shaftalignment.hamarlaser.com

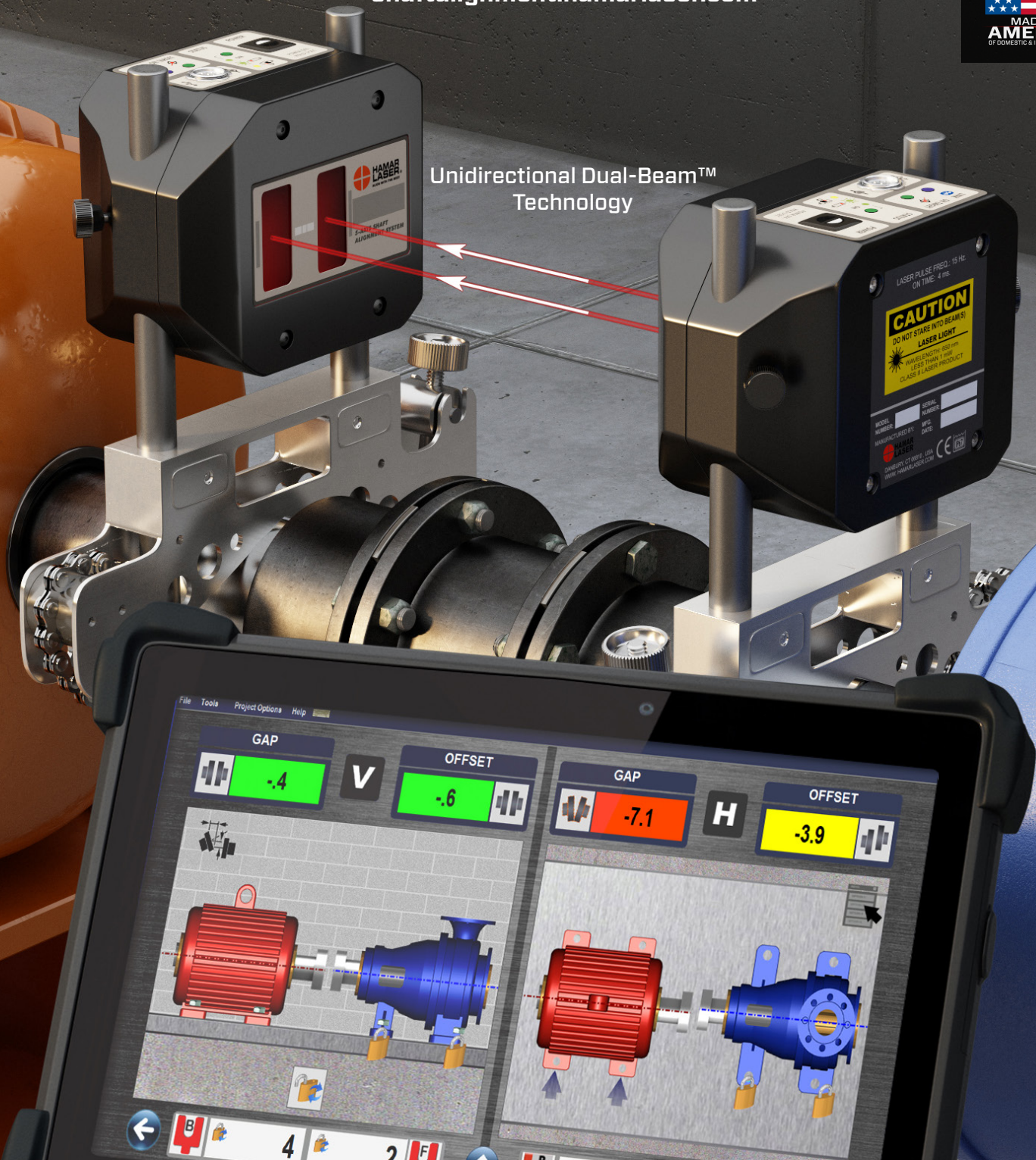

Unidirectional Dual-Beam™
Technology

- Build Your Own™ App Selector
- 5 Year Unconditional Warranty
- Ultra Accuracy for Faster Alignments
- 10" Rugged PC Tablets
- Measurement Error <0.15%
- No Pre-Alignment Required
- Operating Temp. -15°C to 60°C
- Duo-Plane™ Realtime Move Screen

What sets the X-880 System apart from the competition?

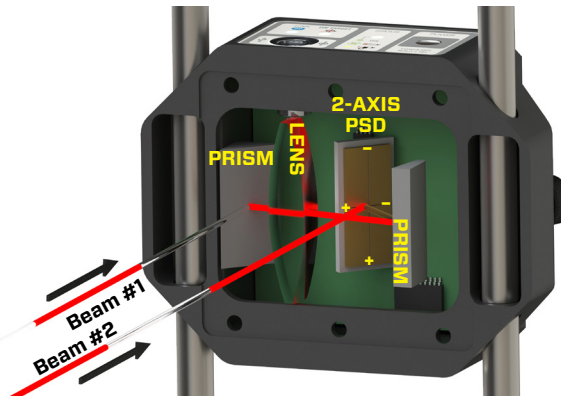

Dual-Beam™ detector technology

A patented technology that allows the measurement of offset and angle simultaneously with only one PSD, increasing accuracy by 50%.

Here's how it works:

1. Beam #1 blinks on and hits PSD measuring the center offsets.
2. Beam #1 blinks off for ambient light correction.
3. Beam #2 blinks on and bounces off one prism, passes through a lens, bounces off a second prism and hits the PSD, measuring the angle.
4. Beam #2 blinks off for a second ambient light correction.

The world's most advanced laser alignment technology

For over 50 years, we have been providing highly accurate alignment systems to many different industries and applications. We started in the machine tool industry where tolerances are high and applications are difficult, and then 30 years ago we developed the world's first 4-axis shaft alignment system. All of that experience and knowledge has gone into the design of the X-880 Wireless 5-Axis Shaft Alignment system resulting in the most accurate and yet easy-to-use tool of its kind. You will find no better or faster system on the market to quickly and accurately align your rotating equipment.

Advanced Unidirectional Dual-Beam™ Technology

This innovative technology provides an amazing $\pm 12^\circ$ of angular range. Utilizing 2 *unidirectional* laser beams (2 lasers, 1 direction), it solves the rough-in (pre-alignment) problem with "cross-fire" lasers (2 lasers, 2 directions) and makes aligning machines amazingly fast and easy, especially on long-distance applications. The result? More jobs done in less time and happier managers!

No rough-in/pre-alignment needed

All "cross-fire" laser alignment systems require a rough-in (pre-alignment) of the machine before the system be able to take data. With Dual-Beam™ technology's 2 unidirectional laser beams and 33 mm sensors, you don't need to rough-in the motor to get it to take data. You get the same measuring range from 2 in. to 30 ft. (50 mm to 10 m), unlike the "cross-fire" kits that have virtually no measuring range beyond 5 ft. (1.5 m). So just slap on the brackets, laser and target and get to work!

Ultra-high fixed angular-measuring resolution

With "cross-fire" laser technology, the angular resolution varies with distance. Ironically it's the close coupled applications that cause the most problems for angular accuracy for these systems. With our Dual-Beam™ technology, you get the same high angular resolution at 2 in. (50 mm) between heads as you get at 30 ft. (10 m), and our angular resolution is 15x higher than the highest angular spec.

Remote tech support

Utilizing the power of Windows, our tech support department can log on remotely to the tablet, via WiFi and the Internet, and troubleshoot many problems. We can usually resolve most issues with an online session, keeping you productive and potentially saving a lot of money on costly returns for repairs.

Duo-Plane™ realtime move screen: alignment corrections without shaft rotation

The Duo-Plane™ realtime move screen and 5-axis target allow you to simultaneously view a live alignment screen for both the vertical and horizontal planes (4 axes) *without* having to rotate the shafts. This is critically important on large machine applications where tightening the bolts can create horizontal movement of the machine, causing you to have to redo the alignment.

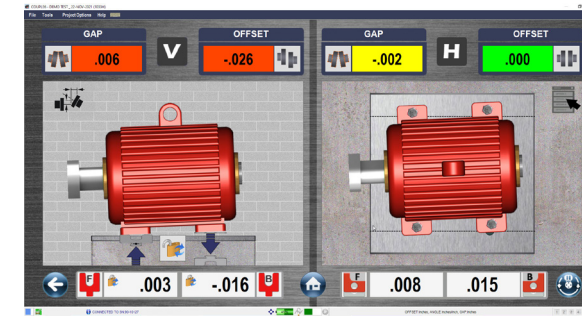

Ultra accuracy means 2x faster alignments

Critical machinery demands the best the industry has to offer and the X-880 platform is up to the task. Super-linear PSD technology and 500-point linearization reduce the error rate to <0.15%, which is up to 15x higher than our competitors, giving you the confidence that the motor is aligned as accurately as possible. Higher accuracy also means better repeatability and more accurate shim calculations so you don't have to keep doing the alignment over and over again. *Shim Once, Move Once™!*

Build Your Own™ app selector

Pick only the apps you want with your X-880, using our Build Your Own™ app selector to customize your apps to meet your individual needs. We recommend a set of apps and you can check on/off the app and the price estimate and license are updated to reflect your choices!

Easy-Guide™ navigation with onboard manual and training videos

Our Couple6 software features our Easy-Guide™ navigation with its easy-to-follow, high-quality screens, leading users through each stage of the alignment. And if you forget how to do something, the manual and training videos are built right into the software! With software this easy to use, a lot of customers start using the X-880 kit right out of the box!

5-year unconditional warranty & low cost of ownership

With no hidden warranty fees like other systems, our 5 Year Unconditional Warranty is really that: no conditions! As long as you don't damage it by abuse, then if something goes wrong, we replace or fix it. That's it. We also don't charge any software maintenance fees. Software updates are free for the life of the product!

Research shows 50% of all machine downtime is the result of poor alignments

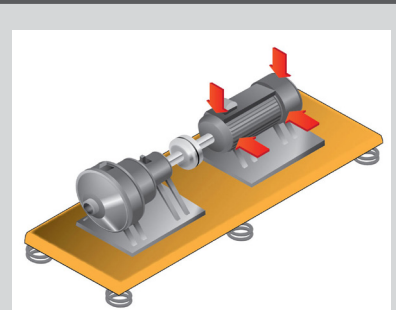

Duo-Plane™ realtime move screen shows live motor graphics of both alignment planes simultaneously.

The X-880 offers familiar rugged IP65 10" tablet PC's to run our Couple6 software that are easy to replace if lost or damaged.



Bluetooth LED – Green means that the Target is connected to the computer. Blinking yellow means data is being transmitted.

Power/USB port – Target can be used while plugged in. Also used for data backup cable.

On Target LED – Red means laser is blocked, green means laser is on on target. Blinking green means Scanning Laser Mode (L-750).

Battery LED – Green means ok, yellow means charge.



Why Unidirectional Dual-Beam™ technology is best for long-distance applications

Alignments over long distances are particularly challenging when working with a 2-laser "cross-fire" shaft systems because it's very sensitive to small angular moves in the motor. For example, a tiny angular movement of just .0005 in/in (0.05 mm/100 mm) at 10 feet (3.1 m) will cause the laser beam to move in offset by 0.060" (1.52 mm)! This makes aligning the motor's offset value very difficult to do, especially for the horizontal axis. With our Dual-Beam™, *unidirectional* laser technology, however, angular moves to motor do not move the laser beam at all and therefore do not affect the offset values! This means aligning the motor is amazingly easy, especially over long distances.

2-laser, "cross-fire" Technology (2 lasers, 2 directions)

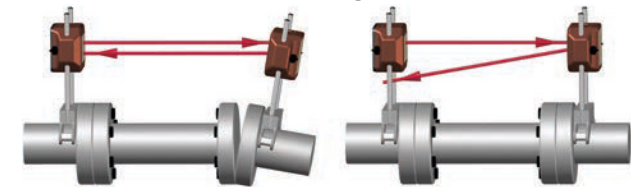

Dual-Beam™ Technology (2 lasers, 1 direction)

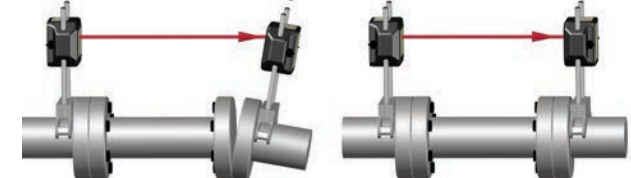

X-880 Couple6 Software for Tablets and PCs with Easy-Guide™ Navigation

Build Your Own™ Features

We designed our Couple6 software to have maximum application flexibility since we know that no 2 techs are the same!

So we created our Build Your Own™ software app selector that allows **you** to choose the shaft-alignment applications that best fit your needs.

Below is what we recommend for the X-880 package. You can swap out recommended apps for optional apps to best fit your needs.

[Click here to choose your apps!](#)

Couple6 Included Apps

- Data Quality Analyzer
- Flip It™
- Machine Templates
- Printed Reports
- Recommended Tolerances with 2 levels

Couple6 Recommended Apps*

- Auto Clock™
- Digital Signature Capture (reporting)
- Horizontal/Vertical Machines
- Save Data/Database Management
- Soft Foot Check
- Templates
- Thermal Growth Calculator (@feet)
- User-Defined Tolerances

* Recommended apps can be exchanged for optional apps.

Optional Software Apps

- Auto Sweep™
- Arc Mode™
- Bolt Bound™
- Data Recorder (Timed/Manual)
- Machine Image Capture (reporting)
- Machine Train-3 Module
- Machine Train-10 Module
- Point Mode
- Repeatability/History
- Spacer Shaft - 7 Formats
- Straightness Data Recorder
- Thermal Growth (@coupling)
- Uncoupled Swipe™ mode
- Vertical Machines - Live Move

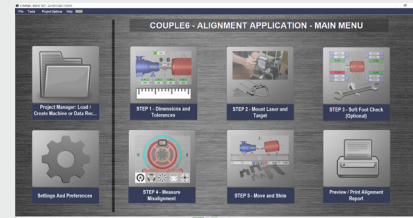

Project Menu

Start new projects, manage old alignment projects, review saved files and create project templates. Creates a unique machine folder that stores all the alignments in one place for easy historical analysis.

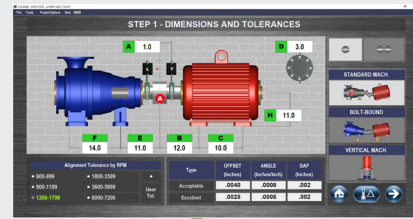

Step 1 - Machine type, Dimensions & Tolerances

Select machine and coupling type, enter dimensions and select tolerances. Can also enter user-defined tolerances.

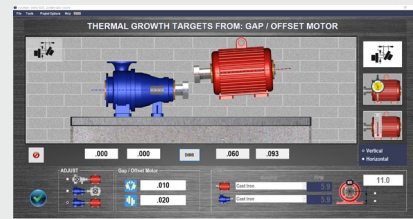

Step 1 - Thermal Growth Modeling

Enter thermal growth values at the coupling or the feet to offset the alignment, and the motor graphics will update to show the effects. Or enter temperature changes at the feet, select the material and Couple6 will calculate the alignment effect at the coupling. Can also be used for alignment modeling before the job starts.

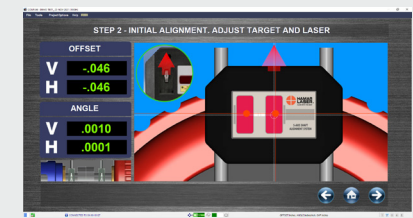

Step 2 - Laser Setup Screen

Provides live, 4-axis, raw alignment data to initialize the system and maximize measurement range. On-screen graphics show you which direction to move the laser and target during the setup. Can also be used for new motor pre-alignment (rough-ins).

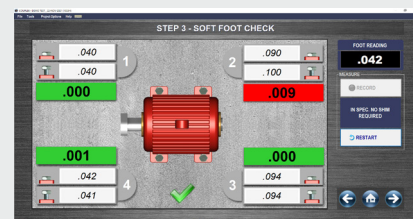

Step 3 - Soft Foot Check

On-screen, easy-to-follow procedure for checking Soft Foot, a common problem that can cause many alignment problems. Automatically selects the "problem" foot and calculates the shim to fix it.

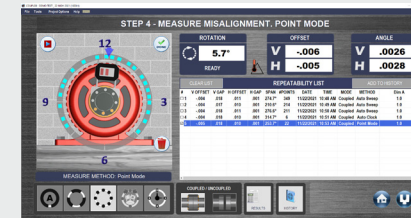

Step 4 - Measure Misalignment

Included in the X-880 App List is Auto-Clock™ an easy and fast method for taking data. Optional Apps include Arc Mode™, Auto Sweep™, Point Mode and Uncoupled Swipe™ Mode. Save multiple sets of data to check repeatability. Archived and assign data categories to track alignments.

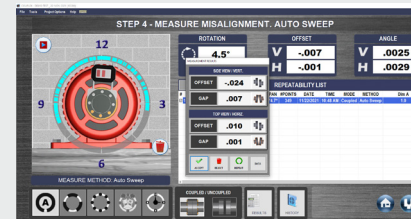

Step 4 - Measurement Results

Click on a set of alignment data to display color-code alignment results. Red means out of tolerance, yellow means "good" and green indicates "excellent". Foot values are also displayed.

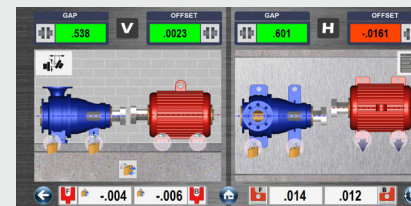

Duo-Plane™ Realtime Move Screen

Alignment values update in as you adjust the motor in all 4 axes (in H & V measurement planes) in real time. This avoids the need to retake data when switching to the Horizontal measurement plane since you can see that updating while you add shims!

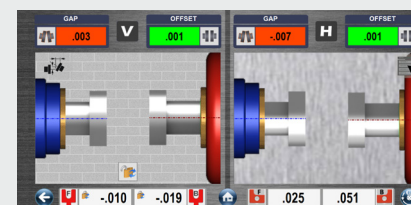

Step 5 - Coupling View

For those users accustomed to gap/offset indicator methods, the Step 5 Realtime Move Screen can be switched to Coupling View to show the alignment directly at the coupling.



On-Board Manuals and Training Videos

Our manual is built right into Couple6 software, so if you have a question, simply click "Help" from the menu, and the software will show the correct page of the manual for that screen. We also loaded our training videos on the tablet, so if you forgot something just click and watch!

Did you know that nearly 50% of the price of our competitor's lasers comes from the display box?

Alignment Report (print or email)



To print, simply plug your tablet into a printer. To email, print report to a PDF and attach to your email. It's that easy.

Free Updates

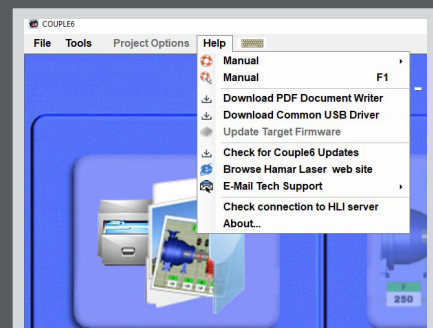

We constantly improve our software and provide free updates. Just click on "Check for Updates" and Couple6 does the work for you.

Couple6 Interactive Tour



Scan here to take an interactive tour of Couple6 on www.hamarlaser.com

Advanced Couple6 Apps

More Advanced Apps

Display Options



X-880 offers familiar rugged, IP65 industrial tablets with 10" touchscreen that run Couple6 and other HLI programs.

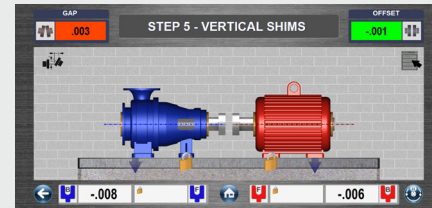

Bolt Bound™

A powerful tool for solving a common problem. Lock/unlock different combinations of the motor and pump feet to see how it affects the alignment solution. The graphics and shim values automatically update with each selection making it easy to find the best solution.

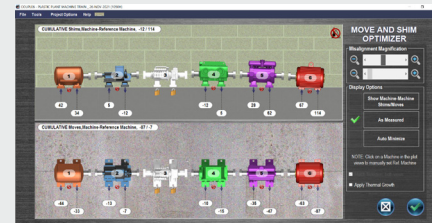
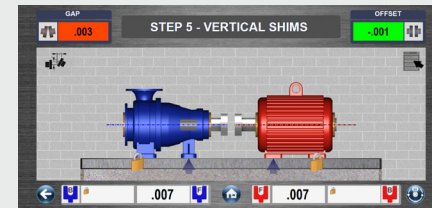

Machine Train Program

Take data on up to 10 machines and the Train Module will calculate the shims/moves that minimizes the moves. Select on any machine to update the shim/moves of other components.

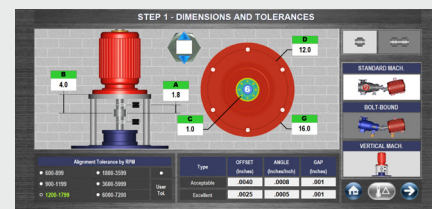
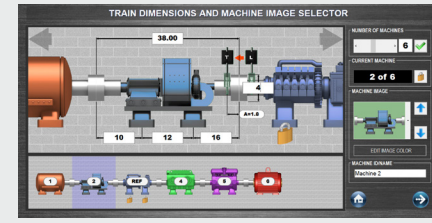

Vertical Motor Program

The industry's only vertical alignment display with live graphical displays of the motor's alignment along with shim values for all bolt-hole locations.

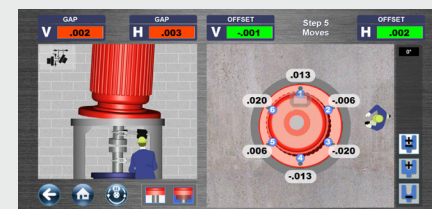

Data Recorder App

Has 3 measuring modes: Flatness, Straightness, Timed/Relative Recording. Use for straightness, pipe strain, thermal growth measurements, etc.



Auto Sweep™ Simply the Best Data-Taking Method. Period.

Start rotating the shafts and the built-in accelerometer detects the movement, automatically collecting hundreds of data points. Stop rotating the shafts and Couple6 starts calculating the misalignment. More data means more accurate alignment data and less rework.

5 Data-Taking Apps

Included in the X-880 App List is Auto-Clock™, data-taking mode, a very easy method for taking data. Optional Apps include Arc Mode™, Auto Sweep™, Point Mode and Uncoupled Swipe™ Mode.

Uncoupled Swipe™ Mode

Makes taking data on uncoupled shafts much easier. Rotate the laser to a clock position and then sweep the target by it, where it automatically records the data point. Collect as few as 3 points and up to 100+ to generate alignment results.

Flip-It™ Screen Graphics

You shouldn't have to turn your screen upside down just because you are on the wrong side of the machine. This very popular feature allows you to flip the graphics with a double-tap of the screen. No more upside-down screens and mixed-up shims.

Measurement Noise Filter

Variable data averaging allows the user to choose the amount of data filtering to reduce the effects of poor measuring environments.

Dynamic Database Management

When you create a new machine in Couple6 software, it automatically creates a folder on your tablet and then saves each new alignment file for that machine in the folder. This allows you to keep a history of alignment for each machine so you can go back and easily collect historical data for trending purposes. Each file is time and date stamped so you can save multiple copies on the same date if needed.

Geometry Add-Ons - Flatness, Straightness, Bore Alignment, etc.

Add the A-987 Rotating Mag Base Fixture and Data Recorder Apps and the L-790 Laser and T-1290 Target can be used to measure flatness & straightness of surfaces or machine axes. For high accuracy flatness apps, add the L-750 Scanning Leveling Laser and A-1519-2.4BT Scanning Target. Bore alignment kits are also available along with software that runs on the tablet for most bore applications.

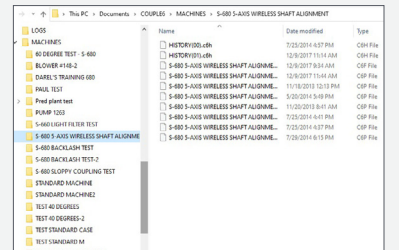
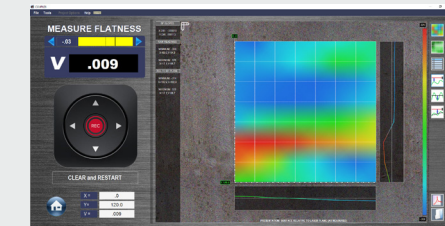

Couple6 controls data integrity by automatically saving alignment data with each click

Included Hardware

A-980 Stainless Steel Brackets

A-980A Chain Bracket Upgrade

Optional Hardware

A-980B Small-Shaft Adapter

A-982 Magnetic Brackets (set of 2)

A-980C Extra Chain Sets 1"-12" Shaft Diameter

A-980NRA Non-Rotating Shaft Brackets

A-980NRB Non-Rotating Large Shaft Bracket

A-980OF Offset Brackets

A-986 Magnetic Coupling-Flange Slider Bracket

T-1285B Narrow-Band Light Filter

Geo Software and Accessories

L-750 Auto-Rotating Laser with P-R base

A-987 Flatness Measuring Fixture for T-1285/T-1290 Targets

S-1396U2 Flatness & Straightness Apps

“ One of the things we like best about the S-680 [X-880] is that you can leave the heads in one position and perform the vertical and horizontal corrections simultaneously with live values.... Then I actually removed and remounted the heads just to double-check because I did not believe I could do it in one move... when I repeated the alignment the results were the same. This made a believer out of me! ”

Justin P.
Condition Monitoring Services

Specifications

Laser/Target Unit Size	4.2 x 3.3 x 2.2 in. (107 x 84 x 55 mm)
Housing Material	Impact resistant plastic
Detector Type & Size	2-axis super-linear PSD 33 mm (V) x 13 mm (H) provides 4 continuously updating alignment axes (or 2 alignment planes).
Ambient Light Protection	Via blinking-laser algorithm embedded in all Hamar Laser targets.
Target Measurement Resolution	Offset: .00002 in. (0.0005 mm) Angular: .00008 in/ft (0.007 mm/m)
Target Measurement Error	Offset: <0.15% Angular: <0.75%
Angular Sensor Range	± 12° (± .204 in/in or 20.4 mm/100 mm). For values > 5°, use only for rough alignment.
Laser Type	650 nm unidirectional Dual-Beam laser with horizontal adjustment <0.9mW
Communication between Target & Data Analyzer	Wireless Bluetooth® Class 1 2.4 ghz plus data communications cable
Wireless Range	Up to 100 ft. (30 m)
Ruggedized Display Platform	Industrial tablet with 10 in. (254 mm) touchscreen. MILSPEC 810G/IP65 R-1342T3-301XC: Standard R-1342T3-301XI: High Performance
Rotation Sensor (5th axis)	Accelerometer Resolution: 0.1° Accuracy: ±1°. Measurement accuracy not affected by rotation sensor accuracy.
Environmental	IP67 (laser & target). IP65 (tablet).
Data Storage Capacity	Virtually Unlimited
Bracket Set	Covers .79 in. (20.0 mm) to 6 in. (152.4 mm) diameter shafts. Comes with 4 in. (101.6 mm), and 8 in. (203.2 mm) posts
Application Range	33 ft. (10 m) between laser and target
Operating/Storage Temperature	Laser/Target: 5°F to 140°F (-15°C to 60°C) R-1342T3-301XC: AC Mode: -4°F to 113°F (-20°C to 45°C) Battery Mode: 32°F to 113°F (0°C to 45°C) R-1342T3-301XI: AC Mode: -4°F to 140°F (-20°C to 60°C) Battery Mode: 32°F to 113°F (0°C to 45°C)
Battery Life Target	14 hours continuous use with Bluetooth® – 15 hours with data communications cable. Target can be plugged into power source during use. Battery status indicator for both Target and PC.
Battery Life Laser	150+ hours continuous use. Blinking LED indicates low battery status
Battery Life Tablet	R-1342T3-301XC: 5 hours, normal use R-1342T3-301XI: 8 hours, normal use
AC Battery Charger (Laser and Target)	110V to 240V with U.S. and international adapters. Charging cable also works as a backup cable



A-980 Bracket set



A-980OF Offset Bracket



A-980NRA Non Rotating Shaft Bracket



A-982 Magnetic Bracket

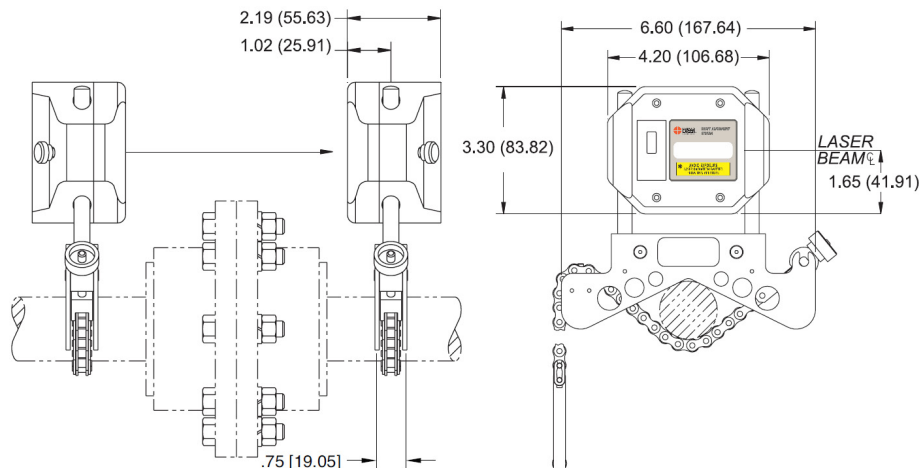

Hamar Laser Instruments, Inc.
5 Ye Olde Road Danbury, CT 06810
Phone: 800.826.6185 Fax: 203.730.4611
Int'l: +1.203.730.4600
E-mail: sales@hamarlaser.com shaftalignment.hamarlaser.com

